

MINIREVIEW

The Notch-Hes pathway in mammalian neural development

KAGEYAMA RYOICHIRO*, TOSHIYUKI OHTSUKA

Institute for Virus Research, Kyoto University, Sakyo-ku, Kyoto 606-8507, Japan

ABSTRACT

A wide variety of neurons and glial cells differentiate from common precursor cells in the developing nervous system. During this process, Notch-mediated cell-cell interaction is essential for maintenance of dividing cells and subsequent generation of cell type diversity. Activation of Notch inhibits cellular differentiation, and abnormality of the Notch pathway leads to premature neuronal differentiation, the lack of some cell types, and severe defects of tissue morphogenesis. Recent data demonstrate that Notch fails to inhibit cellular differentiation in the absence of the bHLH genes *Hes1* and *Hes5*, which functionally antagonize the neuronal bHLH genes such as *Mash1*. These results indicate that the two *Hes* genes are essential effectors for the Notch pathway and that neuronal differentiation is controlled by the pathway "Notch-*Hes1/Hes5*-|*Mash1*".

Key words: *bHLH, Hes, lateral inhibition, neuron, Notch*

INTRODUCTION

During mammalian neural development, a wide variety of neurons and glial cells differentiate from common precursor cells. For example, in the retina, a part of the central nervous system, six types of neurons and one type of glial cells differentiate from common retinal precursor cells[1]. This differentiation proceeds according to the

* Corresponding author: Ryoichiro Kageyama, Institute for Virus Research, Kyoto University, Shogoin-Kawahara, Sakyo-ku, Kyoto 606-8507, Japan
Tel: 81-75-751-4011 Fax: 81-75-751-4807 e-mail: rkageyam@virus.kyoto-u.ac.jp

The Notch-Hes pathway

cell type-specific kinetics: some cell types such as ganglion cells differentiate only at early stages but others such as rod photoreceptors at later stages, probably responding to the different inductive cues in the environment. Generation of such cell type diversity as well as normal morphogenesis involves the cell-cell interaction process, so called "lateral inhibition". During this process, early-differentiating cells send a signal to the neighboring cells to inhibit them from differentiating into the same cell types[2]. The transmembrane protein Notch plays an essential role in the lateral inhibition process: Differentiating cells express the Notch ligands (Delta, Jagged, Serrate) on the cell surface and activate Notch of the neighboring cells. Notch activation inhibits cellular differentiation, thereby maintaining dividing precursor cells and enabling the inhibited cells to adopt different cell types at later stages[3]. In the absence of the Notch pathway, dividing cells decrease and the majority of, or all, cells prematurely differentiate into the early-born cell types, resulting in small-sized disorganized tissues and the lack of late-born cell types. Thus, the Notch-dependent lateral inhibition is critical to generate correct tissue morphogenesis and cell type diversity, although the mechanism for inhibition of differentiation by Notch still remains to be analyzed. Recent data demonstrated that basic helix-loop-helix (bHLH) genes, Hes1 and Hes5 (mammalian homologues of *Drosophila* hairy and Enhancer of split), play an important role in the Notch pathway[3-5]. In this review, we describe the current view of the mammalian Notch pathway.

The Notch pathway: cleavage and translocation of Notch

Notch is a transmembrane protein with epidermal growth factor (EGF) repeats in the extracellular domain and ankyrin repeats in the intracellular domain (Fig 1). There are, at least, four different but related Notch genes (Notch1 to 4) in mice, which show distinct spatio-temporal expression patterns. Notch is processed at the extracellular domain by a furin-like protease and present as a heterodimeric molecule (Fig 1)[2]. This Notch molecule can be activated by its ligands expressed by neighboring cells. There are several Notch ligands in mice: Delta, Jagged, and Serrate. These ligands also have EGF repeats at the extracellular domain like Notch. When Notch is activated by its ligands, the intracellular domain (ICD) of Notch is likely to be cleaved by γ -secretase (Fig 1)[6],[7]. This protease may be encoded by presenilin1, a gene responsible for Alzheimer's disease (AD)[7]. In AD patients, the affected Presenilin1 seems to cleave β -amyloid precursor protein to generate amyloid-b peptide, which is deposited in the brains of AD patients.

After cleavage of Notch by γ -secretase, Notch ICD is then translocated into the nucleus and forms a complex with the DNA-binding protein RBP-J[9]. When RBP-J-binding sites in the Hes1 promoter were disrupted, the complex cannot interact with the promoter and Hes1 upregulation was completely abolished (Fig 2, Hes1/RBP-J(-)). Since Hes1 and Hes5 are known to inhibit neuronal differentiation[10], the above data suggest that the two Hes genes may mediate Notch-induced inhibition of cellular

differentiation.

Interestingly, although four Notch genes have a conserved structure, recent analysis indicated that Notch1 and Notch3 are functionally different. While Notch1 ICD upregulates Hes1 promoter activity very efficiently as mentioned above, Notch3 ICD does not. Or rather, Notch3 ICD represses Notch1 ICD-dependent transcriptional activation[11]. Hes5 expression is thus repressed in mouse embryos overexpressing Notch3 ICD. Notch3 ICD seems to compete with Notch1 ICD for a common coactivator as well as RBP-J[11]. Thus, in some cases Hes expression is subject to both positive and negative regulation by the Notch activation.

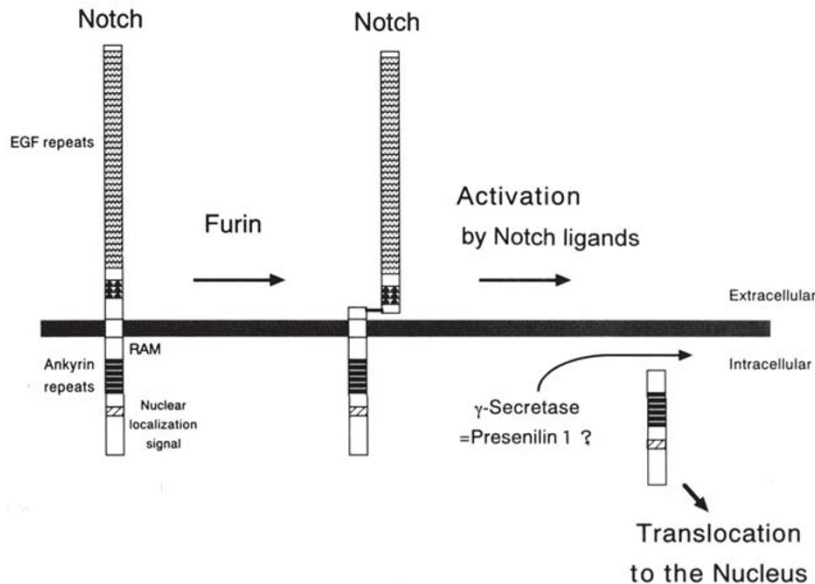

Fig 1.

Cleavage and translocation of Notch.

Notch is processed by Furin and present as a heterodimeric molecule. When Notch is activated by its ligand, the intracellular domain of Notch is cleaved by γ -secretase and translocated into the nucleus, where it forms a complex with the DNA-binding protein RBP-J.

Hes1 and Hes5: transcriptional repressors

Hes1 and Hes5 encode bHLH factors that repress transcription by two different mechanisms[12,13]. One mechanism is “active repression” mediated by corepressor Groucho (Fig 3A). Both Hes1 and Hes5, which can bind to the N box sequence (CACNAG), have the four-amino-acid sequence WRPW at the carboxyl terminus. The

The Notch-Hes pathway

corepressor Groucho, which actively represses transcription, interacts with this WRPW sequence[14]. Thus, in association with Groucho, Hes1 and Hes5 directly bind to the N box and actively repress gene expression. For example, Hes1 is shown to bind to the N box-related sequence of the Mash1 promoter and repress Mash1 transcription[15]. The other mechanism is a dominant-negative regulation (Fig 3B). Most bHLH factors such as Mash1 bind to the E box (CANNTG) and activate gene expression. Hes1 and Hes5 form a non-functional heterodimer with such bHLH activators and inhibit their activity [12,13]. For example, Hes1 dominant-negatively inhibits Mash1-dependent transcription. Thus, Hes1 and Hes5 repress transcription through the N and E boxes by different

Fig 2.

Activation of Notch induces Hes1 and Hes5 expression (adopted from Ref 9).

The luciferase reporter gene under the control of various Hes promoters are coexpressed with (+) or without (-) the active form of Notch1. Only Hes1 and Hes5 promoter activities are upregulated by Notch1. This upregulation is mediated by RBP-J because only Hes1 and Hes5 promoters contain RBP-J-binding sites and because disruption of RBP-J-binding sites in the Hes1 promoter [Hes1/RBP-J(-)] completely abolished the upregulation by Notch1.

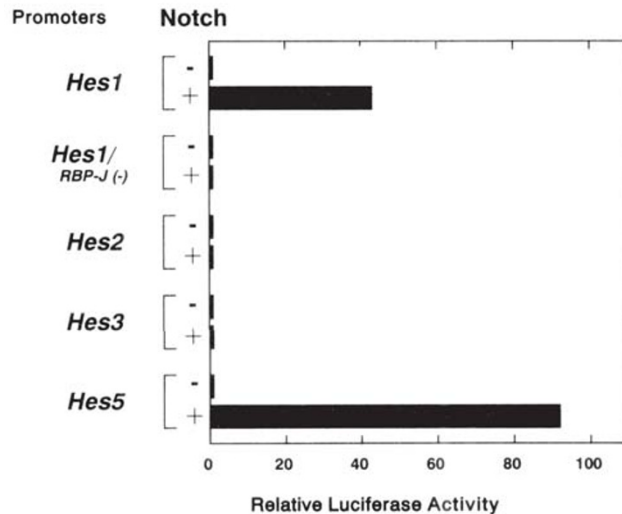

mechanisms.

Hes1 and Hes5 as Notch effectors

The notion that Notch and Hes function in the same pathway is supported by the analysis of knock-out mice. In Hes1-deficient mice, neurons differentiate prematurely before precursor cells proliferate, resulting in severe defects of the neural tube formation such as anencephaly and abnormalities of eye morphogenesis[16,17]. In these mice, Mash1 expression prematurely occurs and is also upregulated, suggesting that this Mash1 upregulation may account for premature neuronal differentiation in the absence of Hes1. Similarly, in Hes5-deficient mice neurons prematurely differentiate although Hes5 deficiency seems to be later compensated[18]. Similar phenotype of prema-

ture neuronal differentiation is also observed in both Notch1-deficient and RBP-J-deficient mice[19], indicating that Notch, RBP-J and Hes function in the same pathway to prevent premature differentiation.

The definitive evidence for Hes1 and Hes5 as essential Notch effectors is presented by the experiments to determine the Notch effects in the absence of Hes genes[18]. When the extracellular domain is deleted, Notch is known to function constitutively. When this deletion fragment of Notch is expressed with retrovirus (caNotch-AP, Fig 4A) in neural precursor cells, the virus-infected cells were negative for the neuronal

A. Active Repression

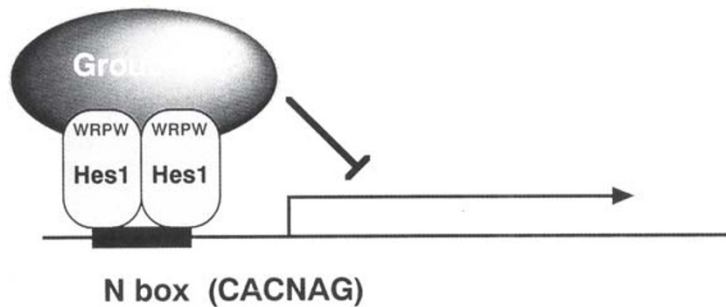

B. Dominant-Negative Effect

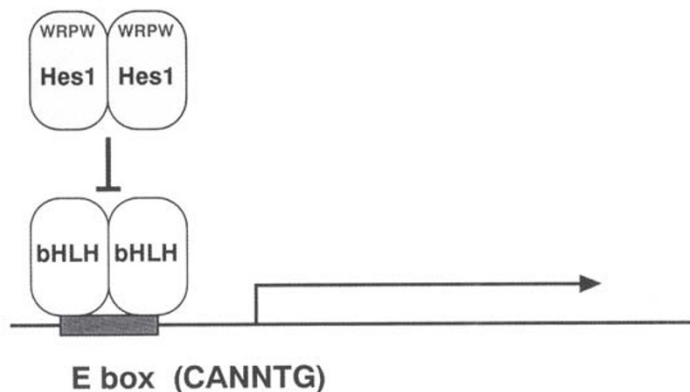

Fig 3.

Two mechanisms of transcriptional repression by Hes1.

(A) Active repression. Hes1 forms a dimer and binds to the N box. The corepressor Groucho interacts with the carboxy-terminal WRPW and mediates active repression.

(B) Dominant-negative effect. Most bHLH factors bind to the E box and activate gene expression. Hes1 shows a dominant-negative effect on these bHLH activators by forming a non-functional heterodimer complex.

The Notch-Hes pathway

marker MAP2 and formed large clusters without any neurite extension (Fig 4B-D).

Thus, their neuronal differentiation was blocked. caNotch-AP infection still blocked neuronal differentiation of precursor cells prepared from Hes1 knock-out (Fig 4E-G) or Hes5 knock-out mice (Fig 4H-J) but not from Hes1-Hes5 double knock-out mice (Fig 4K-M)[18]. These results strongly support the conclusion that Hes1 and Hes5 are essential Notch effectors. Thus, neuronal differentiation is controlled by the pathway "Delta-Notch-RBP-J-Hes1/ Hes5- |Mash1". This negative regulation by Notch and Hes seems to be essential for Mash1 to function at the proper timing. However, some Hes1-Hes5 double-null cells are still inhibited by caNotch-AP infection from differentiating as mature neurons[18], suggesting that Notch can still partially function independently of Hes1 and Hes5. The molecular nature of Hes1-Hes5-independent Notch pathway is a current hot topic[20,21] and remains to be analyzed.

Inner ear development and the Notch pathway

The importance of the Notch pathway in generation of cell type diversity in mammals is shown by analysis of inner ear development. Hair cells (neurons) and support cells differentiate from common precursors in the inner ear. Ablation of hair cells activates support cells, which first divide and then differentiate into a hair cell and a support cell again, suggesting that support cells receive an inhibitory signal from neighboring hair cells. Actually, hair cells express Jagged2, one of Notch ligands, and support cells express Notch, indicating that hair cells inhibit the neighboring support cells from differentiating as hair cells through the Notch pathway (Fig 5)[22]. In Jagged2 deficient mice, this inhibition is affected, resulting in the increase of hair cells at the expense of support cells[22]. This Jagged2-dependent Notch activation probably targets to the bHLH gene Math1, which is essential for generation of hair cells[23,24]. Thus, in the inner ear the pathway "Jagged2-Notch- RBPJ-Hes1/Hes5- |Math1" regulates generation of hair cells and support cells, and abnormality of this pathway leads to the lack of one of the two cell types.

Fig 4. ▷

Hes1 and Hes5 as essential Notch effectors (adopted from Ref 18).

(A) Schematic structure of caNotch-AP. The fragment of a constitutively active form of Notch, which consists of the RAM, ankyrin repeats, and nuclear localization signal, is expressed from the upstream LTR promoter. Alkaline phosphatase (AP) is also expressed through the IRES (internal ribosomal entry site).

(B-M) Neural precursor cells were prepared from wild type (B-D), Hes1-null (E-G), Hes5-null (H-J), and Hes1-Hes5 double-null embryos (K-M). These cells were infected with caNotch-AP and, two weeks after infection, the fates of the virus-infected cells (AP+) were determined. caNotch-AP infection inhibited neuronal differentiation of wild-type, Hes1-null, and Hes5-null cells (AP+, MAP2-) (i.e, the absence of cells expressing both AP and MAP2) but not of Hes1-Hes5 double-null cells (AP+, MAP2+). Thus, Hes1 and Hes5 are essential for Notch-induced inhibition of neuronal differentiation.

A

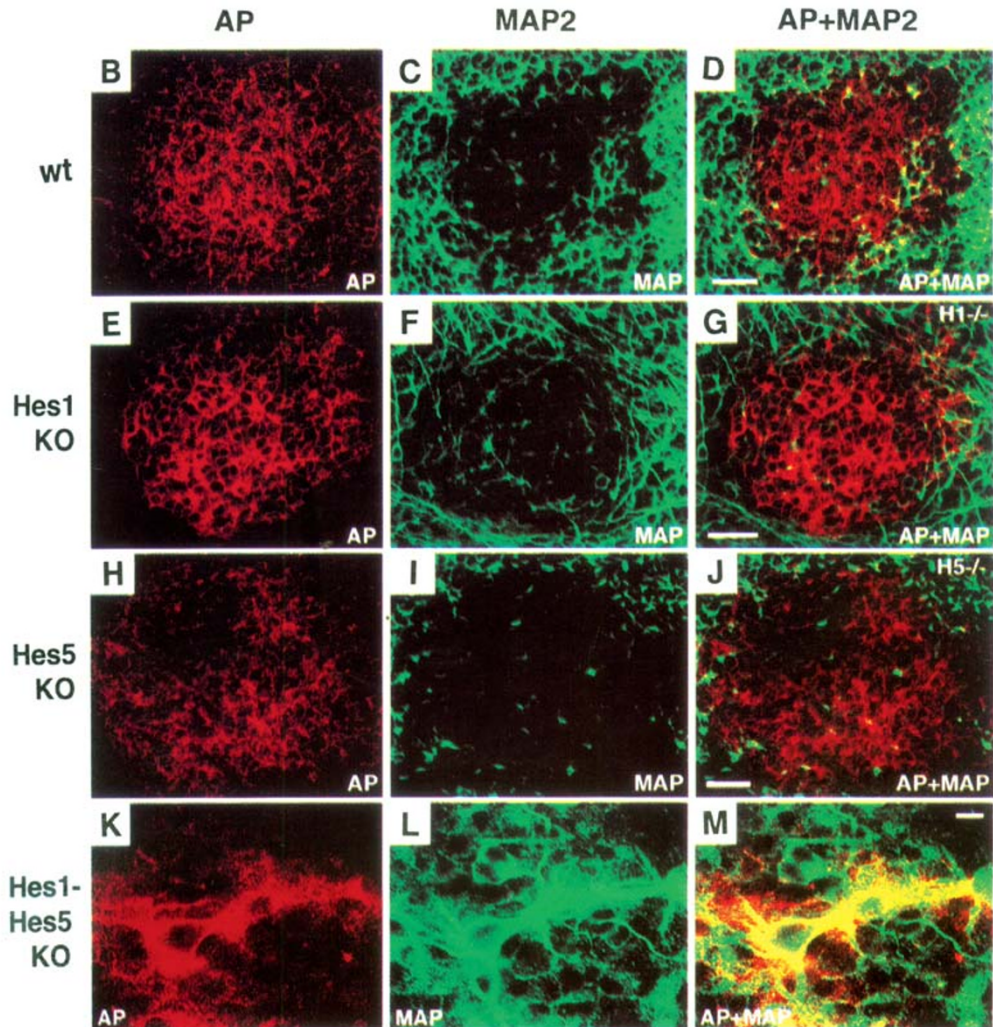
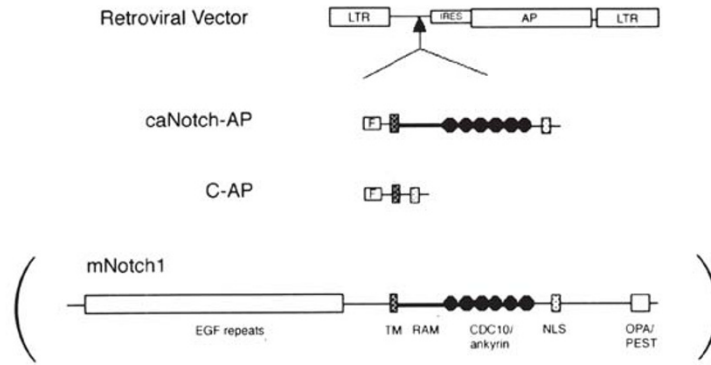

The Notch-Hes pathway

Fig 5.

The Notch pathway in inner ear development.

Hair cells express Jagged2 and activate Notch of support cells. In the absence of Jagged2, support cells are converted into hair cells. Thus, the Notch pathway is essential for generation of two cell types in the inner ear.

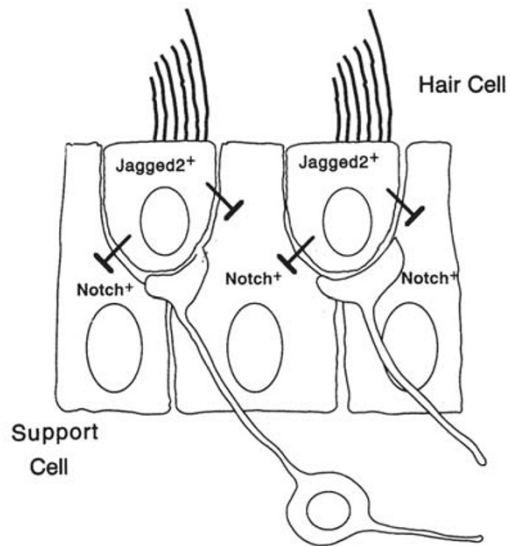

The Notch-Hes pathway in other cell types

The Notch-Hes pathway is involved in differentiation of other tissues and cell types as well, such as blood cells, endocrine-exocrine cells, and somites. For example, this pathway plays an essential role in T cell development; In the absence of either Notch1 or Hes1, T cell development is arrested at the earliest phase before T cell receptor gene rearrangement, indicating that both Notch1 and Hes1 are essential for T cell fate specification[25], [26]. In addition, both Notch1 and Hes1 also regulate later stages of T cell development such as generation of CD8 single-positive cells from CD4CD8 double-positive cells[27],[28]. Interestingly, gene disruption of Notch1 or Hes1 does not affect B cell development.

In addition, the abnormality of the Notch pathway is shown to be involved in various diseases including leukemia and hereditary neurological disorders such as CADASIL (cerebral autosomal dominant arteriopathy with subcortical infarcts and leukoencephalopathy)[29],[30]. However, it remains to be determined whether Hes genes are also involved in these diseases. Further characterization of the Notch pathway should provide insight into the mechanism and therapy for such diseases.

ACKNOWLEDGEMENT

This work was supported by Special Coordination Funds for Promoting Science and Technology and research grants from the Ministry of Education, Science, Sports, and Culture of Japan and Japan Society for the Promotion of Science.

REFERENCES

- [1] Cepko CL, Austin CP, Yang X, Alexiades M, Ezzeddine D. Cell fate determination in the vertebrate retina. *Proc Natl Acad Sci USA* 1996; 93:589-95.

- [2] Artavanis-Tsakonas S, Rand MD, Lake RJ. Notch signaling: cell fate control and signal integration in development. *Science* 1999; 284:770-6.
- [3] Jarriault S, Brou C, Logeat F, Schroeter EH, Kopan R, Israel A. Signalling downstream of activated mammalian Notch. *Nature* 1995; 377:355-8.
- [4] Kageyama R, Nakanishi S. Helix-loop-helix factors in growth and differentiation of the vertebrate nervous system. *Curr Opin Genet Dev* 1997; 7:659-65.
- [5] Hsieh JJ-D, Nofziger DE, Weinmaster G, Hayward SD. Epstein-Barr virus immortalization: Notch2 interacts with CBF1 and blocks differentiation. *J virol* 1997; 71:1938-45.
- [6] Schroeter EH, Kisslinger JA, Kopan R. Notch-1 signalling requires ligand-induced proteolytic release of intracellular domain. *Nature* 1998; 393:382-6.
- [7] Chan Y-M, Jan YN. Presenilins, processing of b-amyloid precursor protein, and Notch signaling. *Neuron* 1999; 23:201-4.
- [8] Honjo T. The shortest path from the surface to the nucleus: RBP-J k/Su(H) transcription factor. *Genes Cells* 1996; 1:1-9.
- [9] Nishimura M, Isaka F, Ishibashi M, et al. Structure, chromosomal locus, and promoter of mouse Hes2 gene, a homologue of Drosophila hairy and Enhancer of split. *Genomics* 1998; 49:69-75.
- [10] Ishibashi M, Moriyoshi K, Sasai Y, Shiota K, Nakanishi S, Kageyama R. Persistent expression of helix-loop-helix factor HES-1 prevents mammalian neural differentiation in the central nervous system. *EMBO J* 1994; 13:1799-805.
- [11] Beatus P, Lundkvist J, Berg C, Lendahl U. The Notch3 intracellular domain represses Notch1-mediated activation through Hairy/Enhancer of split (HES) promoters. *Development* 1999; 126:3925-35.
- [12] Sasai Y, Kageyama R, Tagawa Y, Shigemoto R, Nakanishi S. Two mammalian helix-loop-helix factors structurally related to Drosophila hairy and Enhancer of split. *Genes Dev* 1992; 6:2620-34.
- [13] Akazawa C, Sasai Y, Nakanishi S, Kageyama R. Molecular characterization of a rat negative regulator with a basic helix-loop-helix structure predominantly expressed in the developing nervous system. *J Biol Chem* 1992; 267:21879-85.
- [14] Paroush Z, Finley Jr RL, Kidd T, et al. Groucho is required for Drosophila neurogenesis, segmentation, and sex determination and interacts directly with hairy-related bHLH proteins. *Cell* 1994; 79:805-15.
- [15] Chen H, Thiagalingam A, Chopra H, et al. Conservation of the Drosophila lateral inhibition pathway in human lung cancer: a hairy-related protein (HES-1) directly represses achaete-scute homolog-1 expression. *Proc Natl Acad Sci USA* 1999; 79:5355-60.
- [16] Ishibashi M, Ang S-L, Shiota K, Nakanishi S, Kageyama R, Guillemot F. Targeted disruption of mammalian hairy and Enhancer of split homolog-1 (HES-1) leads to up-regulation of neural helix-loop-helix factors, premature neurogenesis, and severe neural tube defects. *Genes Dev* 1995; 9:3136-48.
- [17] Tomita K, Ishibashi M, Nakahara K, et al. Mammalian hairy and Enhancer of split homolog 1 regulates differentiation of retinal neurons and is essential for eye morphogenesis. *Neuron* 1996; 16:723-34.
- [18] Ohtsuka T, Ishibashi M, Gradwohl G, Nakanishi S, Guillemot F, Kageyama R. Hes1 and Hes5 as Notch effectors in mammalian neuronal differentiation. *EMBO J* 1999; 18:2196-207.
- [19] de la Pompa JL, Wakeham A, Correia KM, et al. Conservation of the Notch signalling pathway in mammalian neurogenesis. *Development* 1997; 124:1139-48.
- [20] Matsuno K, Eastman D, Mitsiades T, et al. Human deltex is a conserved regulator of Notch signalling. *Nature genet* 1998; 19:74-8.
- [21] Ordentlich P, Lin A, Shen C-P, et al. Notch inhibition of E47 supports the existence of a novel signaling pathway. *Mol Cell Biol* 1998; 18:2230-9.
- [22] Lanford PJ, Yan Y, Jiang R, et al. Notch signalling pathway mediates hair cell development in mammalian cochlea. *Nature genet* 1999; 21:289-92.

The Notch-Hes pathway

- [23] Akazawa C, Ishibashi M, Shimizu C, Nakanishi S, Kageyama R. A mammalian helix-loop-helix factor structurally related to the product of *Drosophila* proneural gene *atonal* is a positive transcriptional regulator expressed in the developing nervous system. *J Biol Chem* 1995; 270:8730-8.
- [24] Bermingham NA, Hassan BA, Price SD, et al. *Math1*: an essential gene for the generation of inner ear hair cells. *Science* 1999; 284:37-41.
- [25] Tomita K, Hattori M, Nakamura E, Nakanishi S, Minato N, Kageyama R. The bHLH gene *Hes1* is essential for expansion of early T cell precursors. *Genes Dev* 1999; 13:1203-10.
- [26] Radtke F, Wilson A, Stark G, et al. Deficient T cell fate specification in mice with an induced inactivation of *Notch1*. *Immunity* 1999; 10:547-58.
- [27] Kim HK, Siu G. The Notch pathway intermediate HES-1 silences CD4 gene expression. *Mol Cell Biol* 1998; 18:7166-75.
- [28] Robey E, Chang D, Itano A, et al. An activated form of Notch influences the choice between CD4 and CD8 T cell lineages. *Cell* 1996; 87:483-92.
- [29] Joutel A, Corpechot C, Ducros A, et al. *Notch3* mutations in CADASIL, a hereditary adult-onset condition causing stroke and dementia. *Nature* 1996; 383:707-10.
- [30] Ellisen LW, Bird J, West DC, et al. TAN-1, the human homolog of the *Drosophila* Notch gene, is broken by chromosomal translocations in T lymphoblastic neoplasms. *Cell* 1991; 66:649-61.